

Ogi Y

technische Beschreibung



.mdd

.mdd befindet sich seit Jahren in Gruppe der besten Produzenten, die auf Büromöbel spezialisiert sind.

Von unserer Qualität zeugen die von uns erhaltenen Auszeichnungen sowie die immer steigende Nachfrage nach den von uns angebotenen Produkten.

Die Realien des heutigen Markts erfordern ständiges Verbessern der Qualität - sowohl des Produkts als auch der Tätigkeiten innerhalb der Firma. Dies betrifft vor allem, neben Qualität dre Unternehmen verlaufenden Prozesse, Handelsdienstleistung und Marketing. .mdd gehört mit Sicherheit zu den Unternehmen, die für alle erwähnten Bedingungen sorgen, da siese die Grundlage des ökonomischen Firmenerfolgs sind.

Die ständigen Investitionen in den Maschinenpark, Optimierung der Verwaltungssysteme und Erweiterung der Fläche von Produktionshallen lassen uns die Zeit reduzieren, die für die Produktion eines hochqualotativen, fertigen Produkts nötig ist.

Unsere langjährige Erfahrung im Bereich von Produktion der Büromöbel bestätigt eine Referenzliste der Firmen und Institutionen, die unsere Leistungsfähigkeit und komplexen Service zu schätzen wissen.

Umweltschutzpolitik... ist eine von unseren Prioritäten.

Ständig investieren wir in die Ausstattung, die uns Energie erhalten lässt. Die industriellen Abfälle werden bei .mdd mit höchster Aufmerksamkeit recycelt. .mdd hat zahlreiche Zertifikate, die unsere Sorge um Abfallverwertung bestätigen.

Alle von uns gebrauchten Materialien sind umweltfreundklich und alle unsere Produkte haben Recyclingquote von 95%.



Allgemeine Informationen:

Gewährleistung:

.mdd-Produkte - **5 Jahre.**

Elektrische Bestandteile und Stoffe

- **2 Jahre.**

Zertifikat - Melaminplatte:



Montage:

Produkt wird in Elementen geliefert

Verpackung:

Karton

Gemäß Normen:

PN-EN 527-2:2017-02

Plattendichte:

12 mm - 690 - 750 kg/m³

18 mm - 650 - 690 kg/m³

28 mm - 610 - 630 kg/m³

36 mm - 610 - 630 kg/m³

Ogi - Platten

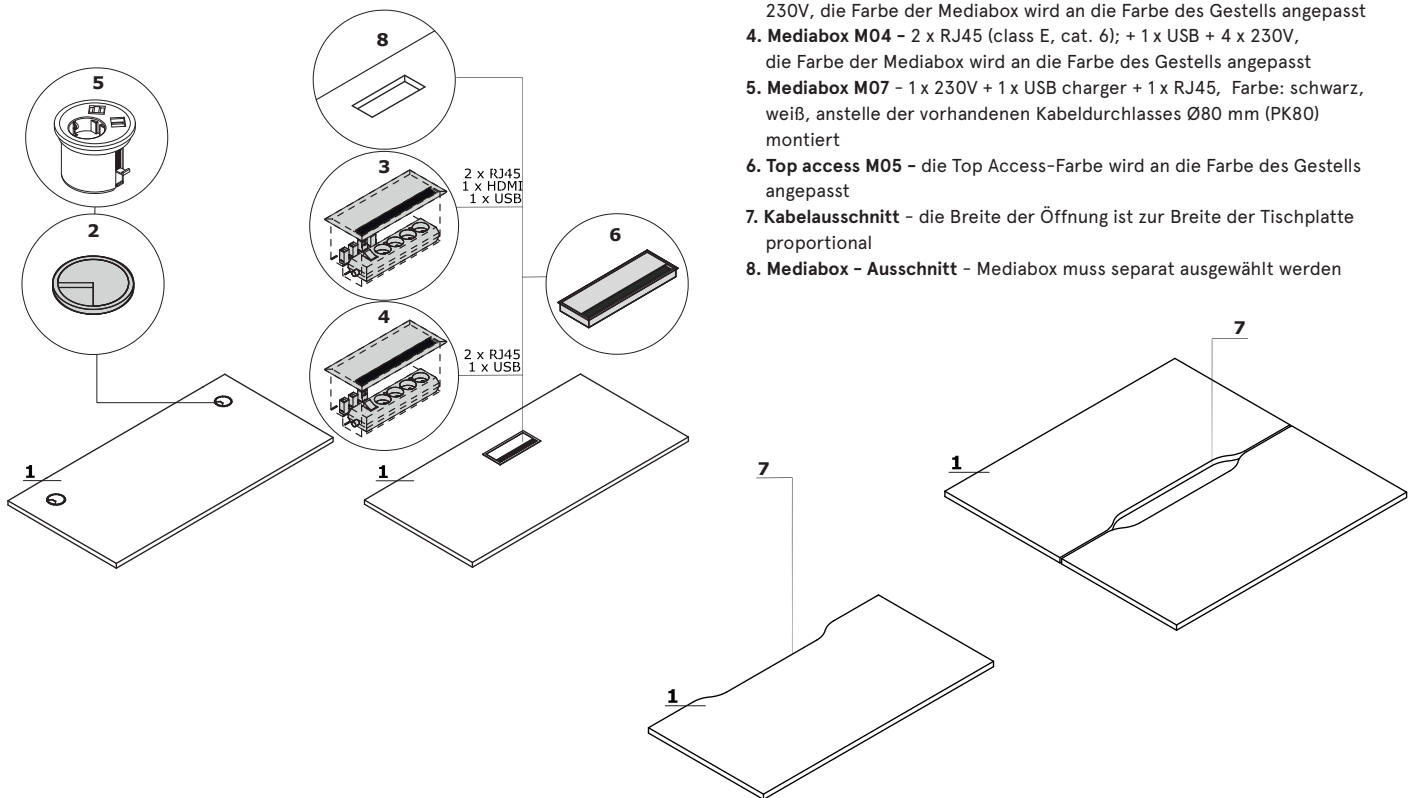

- 1. **Platte** - Melaminplatte 28 mm, Umleimer ABS
- OPTION GEGEN AUFPREIS:**
- 2. **Kabeldurchlass** - 2 Stück, Ø 80 mm
- 3. **Mediabox M04H** - 2 x RJ45 (class E, cat. 6); + 1 x USB + 1 x HDMI + 4 x 230V, die Farbe der Mediabox wird an die Farbe des Gestells angepasst
- 4. **Mediabox M04** - 2 x RJ45 (class E, cat. 6); + 1 x USB + 4 x 230V, die Farbe der Mediabox wird an die Farbe des Gestells angepasst
- 5. **Mediabox M07** - 1 x 230V + 1 x USB charger + 1 x RJ45, Farbe: schwarz, weiß, anstelle der vorhandenen Kabeldurchlasses Ø80 mm (PK80) montiert
- 6. **Top access M05** - die Top Access-Farbe wird an die Farbe des Gestells angepasst
- 7. **Kabelausschnitt** - die Breite der Öffnung ist zur Breite der Tischplatte proportional
- 8. **Mediabox - Ausschnitt** - Mediabox muss separat ausgewählt werden

Abmessungen von Formplatten (mm)

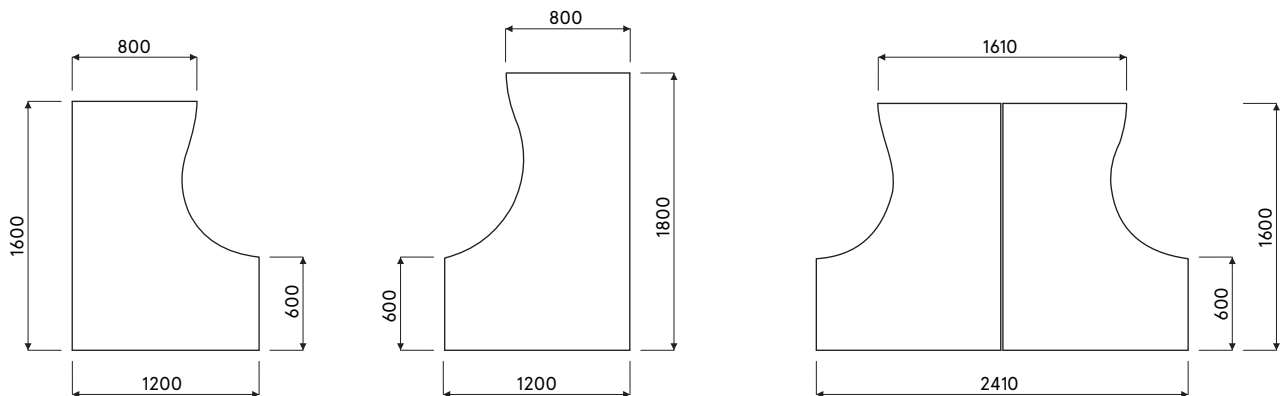

Gestell

Ogi Y: Metall, pulverbeschichtet, Profil 40x40 mm, Abstand 10 mm zwischen Platte und Gestell

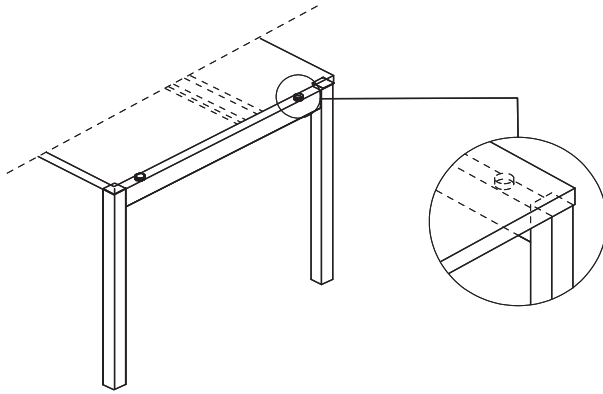

Hinweis - die Schiene unter der Tischplatte ist nur in Aluminium halbmatt M009 erhältlich.

Schreibtisch mit Managerschrank

- 1. **Platte** - Melaminplatte 28 mm, Umleimer ABS
- 2. **Oberplatte** - Melaminplatte 28 mm, Umleimer ABS
- 3. **Fachboden** - Melaminplatte 18 mm, Schutz vor einem zufälligen Ausfahren, Umleimer ABS
- 4. **Schublade** - Melaminplatte 18 mm, Umleimer ABS, Patentschloss; Möglichkeit, Lage der Schublade zu ändern
- 5. **Boden** - Melaminplatte 18 mm, Umleimer ABS
- 6. **Front** - Melaminplatte 18 mm, Umleimer ABS

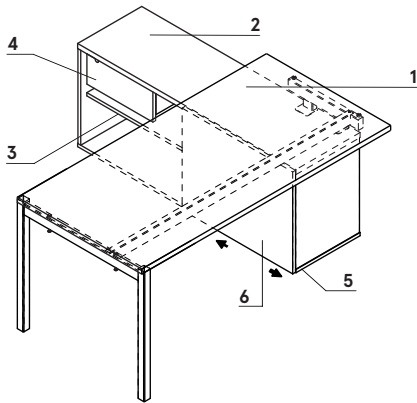

www.mdd.eu

Beispielkonfigurationen (mm)

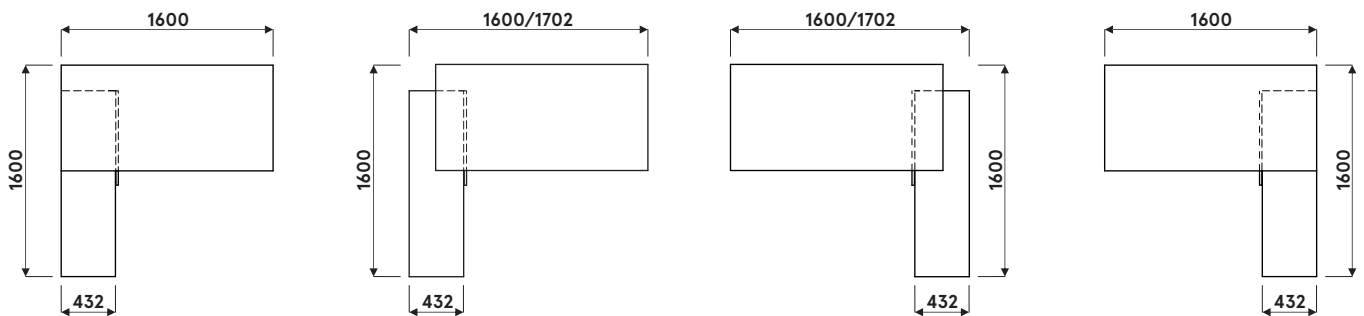

Beispielkonfigurationen (mm)

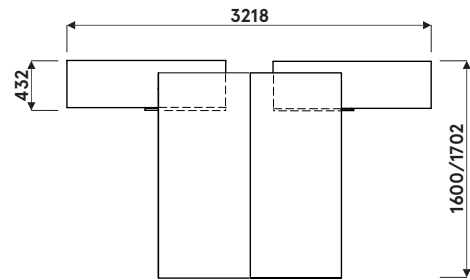
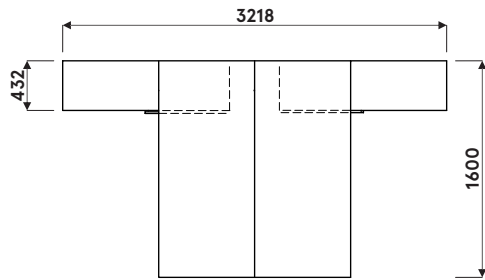

Beispielkonfigurationen mit BOX40, BOX50, BOX60

www.mdd.eu

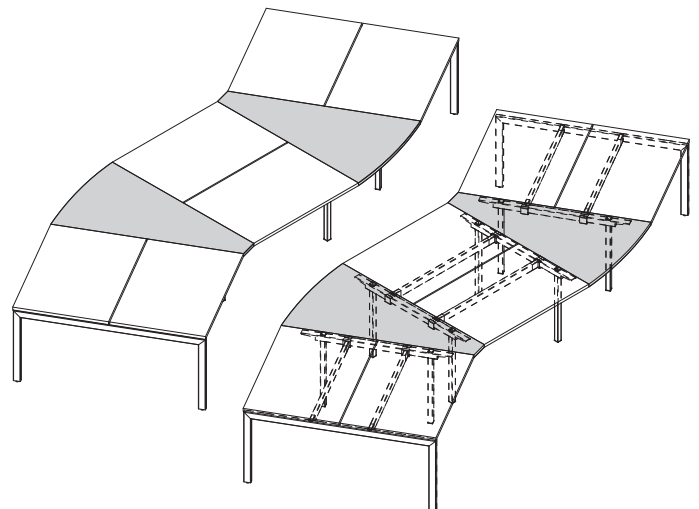
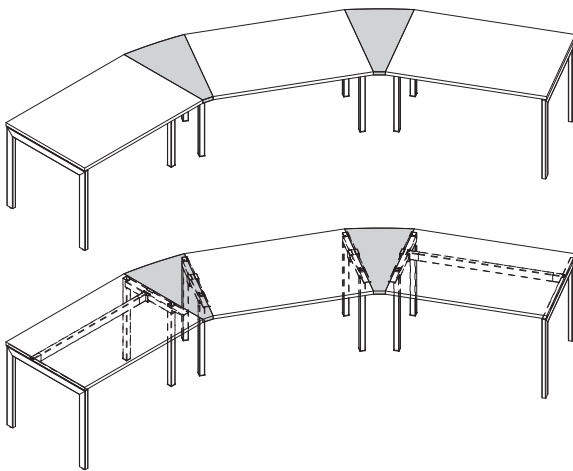

HINWEIS – nur für Ogi Q, Ogi U, Ogi Y, Ogi M

Zubehör

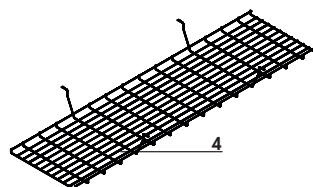
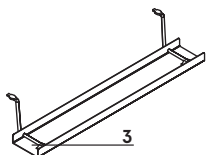
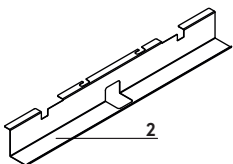
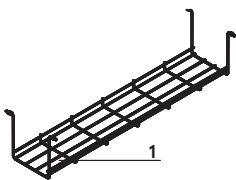

1. Schiene S69 – Metall, pulverbeschichtet, Aluminium - 09
2. Schiene für Einzelschreibtische (SG12, SG16) – Metall, pulverbeschichtet, aluminium halbmatt – M009
3. Schiene E64 – Metall pulverbeschichtet, M009 – aluminium halbmatt
4. Kabelfsiene zu den Bench – Schreibtischen (SG220, SG260) – Stahldraht Ø4 mm, pulverbeschichtet, Farbe 09 – aluminium

Einzelschreibtische



BOY12
1200 / 600 / 740
30.3 kg

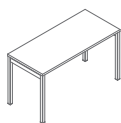

BOY14
1400 / 600 / 740
33.4 kg

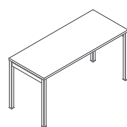

BOY16
1600 / 600 / 740
36.5 kg



BOY22
1200 / 700 / 740
31.7 kg



BOY24
1400 / 700 / 740
35.1 kg

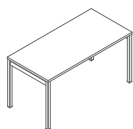

BOY26
1600 / 700 / 740
38.7 kg



BOY02
1200 / 800 / 740
37.3 kg

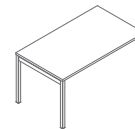

BOY03
1400 / 800 / 740
37.8 kg

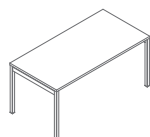

BOY04
1600 / 800 / 740
38.4 kg

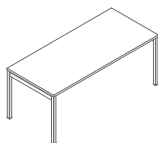

BOY05
1800 / 800 / 740
41.5 kg

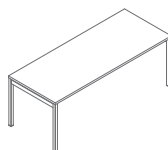

BOY06
2000 / 800 / 740
49.2 kg

www.mdd.eu

Elemente für Systemausbau - gerader Schreibtisch



BOX40
500 / 800 / 740
10.8 kg

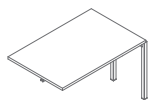

BOX42
1200 / 800 / 740
31.6 kg

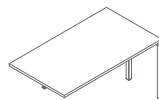

BOX43
1400 / 800 / 740
32.1 kg

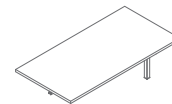

BOX44
1600 / 800 / 740
32.7 kg

Elemente für Systemausbau – gerader Schreibtisch

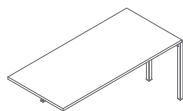

BOX45
1600 / 800 / 740
35.8 kg

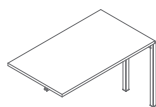

BOX32
1200 / 700 / 740
26.3 kg

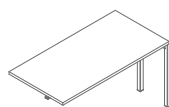

BOX34
1400 / 700 / 740
29.7 kg

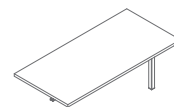

BOX36
1600 / 700 / 740
33.3 kg

Bench-Systeme

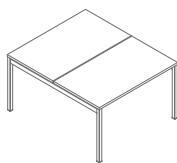

BOY42
1200 / 1410 / 740
57.2 kg

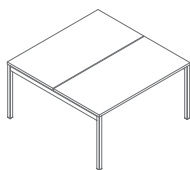

BOY44
1400 / 1410 / 740
64 kg

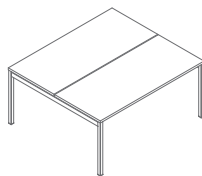

BOY46
1600 / 1410 / 740
71.2 kg

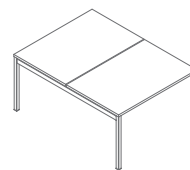

BOY32
1200 / 1610 / 740
68.3 kg

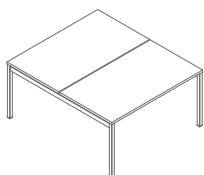

BOY33
1400 / 1610 / 740
69.3 kg

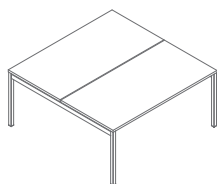

BOY34
1600 / 1610 / 740
70.5 kg

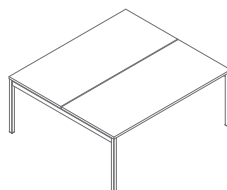

BOY35
1800 / 1610 / 740
76.7 kg

www.mdd.eu

Elemente für Systemausbau – Bench

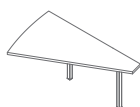

BOX50
1000 / 1410 / 740
16.5 kg

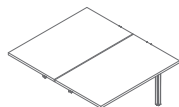

BOX52
1200 / 1410 / 740
49.4 kg

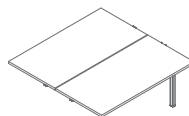

BOX54
1400 / 1410 / 740
56.2 kg

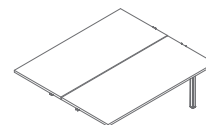

BOX56
1600 / 1410 / 740
63.4 kg

Elemente für Systemausbau - Bench

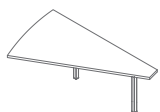

BOX60
1000 / 1610 / 740
17,5 kg

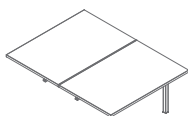

BOX62
1200 / 1610 / 740
60,1 kg

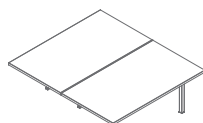

BOX64
1400 / 1610 / 740
61,1 kg

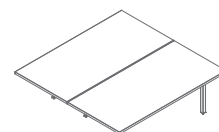

BOX66
1600 / 1610 / 740
62,3 kg

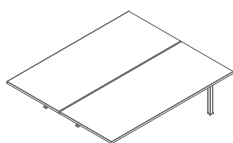

BOX68
1800 / 1610 / 740
68,5 kg

Schreibtische mit Managerschrank

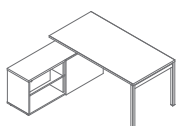

BOYL20
1600-1702 / 1600 / 740
94,1 kg

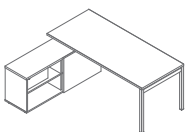

BOYL21
1800-1902 / 1600 / 740
95,6 kg

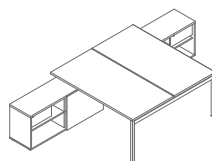

BOYL40
1600-1702 / 3210 / 740
181,9 kg

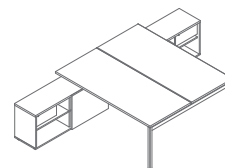

BOYL41
1800-1902 / 3210 / 740
188,1 kg

Ansätze für Schreibtische

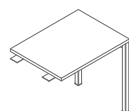

PLY01
600 / 800 / 740
18,7 kg

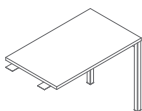

PLY02
600 / 1000 / 740
19,9 kg

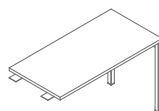

PLY03
600 / 1200 / 740
22,4 kg

Formschreibtische



BOY10
1600 / 1200 / 740
45,6 kg

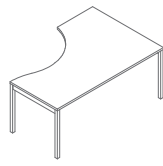

BOY17
1800 / 1200 / 740
41,5 kg

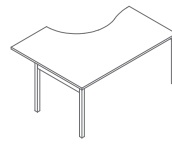

BOY11
1600 / 1200 / 740
45,6 kg

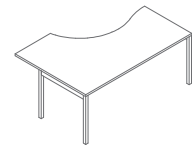



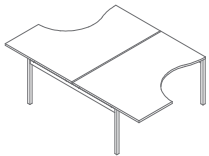



BOY18
1800 / 1200 / 740
43,5 kg



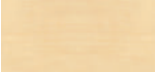

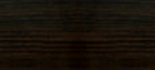
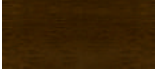
BOY15
1600 / 2410 / 740
84,9 kg

Tischplatte, Oberplatte, Sockel, Korpus, Front

Kabeldurchlass

				→	
14 Buche *	26 Aluminium satinato	31 Kanadische Eiche *	39 Polarbirke *		Aluminium
				→	
67 Weiß Pastel					Weiß
				→	
34 Wenge *	64 Kakao *	106 Nussbaum	154 Anthrazit		Schwarz
					
08 Schwarz	167 Eiche Grau	168 Eiche Natur			

Gestell, Mediabox - Metall

			
M009 Aluminium halbmatt RAL9006	M015 Weiß halbmatt RAL9010	M154 Anthrazit halbmatt RAL7043	M115 Schwarz halbmatt RAL9005

* Korpus - II. Gruppe